

Fiche technique

Accessoires Gaine annelée

Peigne Ø125

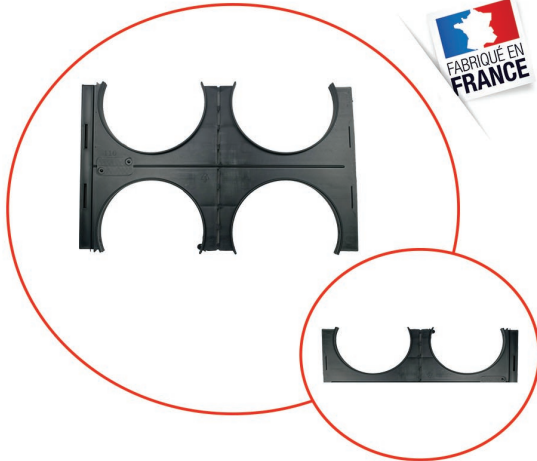

Caractéristiques :

Matière : Polypropylène
Couleur : Noir
Version type : 2x2 (pour 4 tubes) ou 1x2
Diamètre : 125 mm

Utilisation :

Mise en place sans collage et sans outillage. Clipser le tube à la main sur l'alvéole.

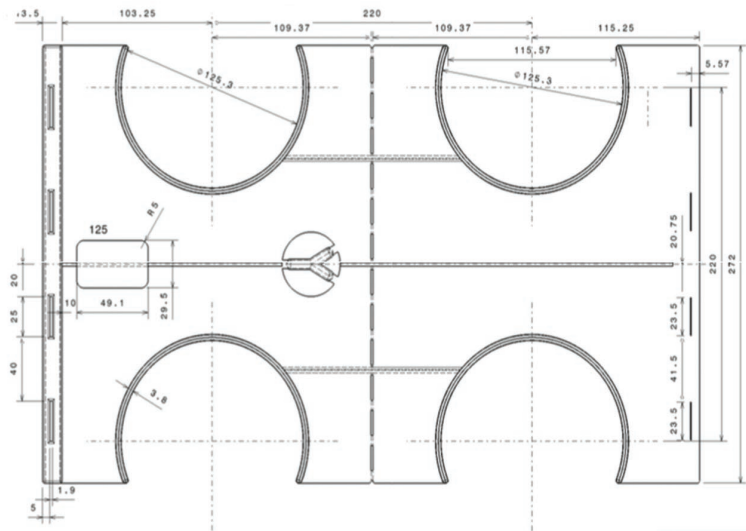

Code article	Désignation	Nb de tubes	Poids en kg	Carton
PEI125_1X2	Peigne diam125 mm version 1x2	2	0.075	40
PEI125_1X3	Peigne diam125 mm version 1x3	3	0.112	30
PEI125_1X4	Peigne diam125 mm version 1x4	4	0.150	20
PEI125_1X5	Peigne diam125 mm version 1x5	5	0.187	NC
PEI125_1X6	Peigne diam125 mm version 1x6	6	0.225	NC
PEI125_1X7	Peigne diam125 mm version 1x7	7	0.262	NC
PEI125_1X8	Peigne diam125 mm version 1x8	8	0.300	NC
PEI125_1X9	Peigne diam125 mm version 1x9	9	0.337	NC
PEI125_1X10	Peigne diam125 mm version 1x10	10	0.375	NC
PEI125	Peigne diam125 mm version 2x2	4	0.150	20
PEI125_2x3	Peigne diam125 mm version 2x3	6	0.225	15
PEI125_2x4	Peigne diam125 mm version 2x4	8	0.300	10
PEI125_2x5	Peigne diam125 mm version 2x5	10	0.375	NC
PEI125_2x6	Peigne diam125 mm version 2x6	12	0.450	NC
PEI125_2x7	Peigne diam125 mm version 2x7	14	0.525	NC
PEI125_2x8	Peigne diam125 mm version 2x8	16	0.600	NC
PEI125_2x9	Peigne diam125 mm version 2x9	18	0.675	NC
PEI125_2x10	Peigne diam125 mm version 2x10	20	0.750	NC